

**OT System**

*Operative  
Office System*

**O**T

**fantoni**

**OT System** design: Mario Broggi,  
Michael Burckhardt architetti

*Operative  
Office System*

# OT

**fantoni**

**OT Systems**  
index**OT Tables** 04**Quadra** 08  
**Round** 18  
**Mono "T"** 28  
**Mono "P"** 32**OT Storage Units** 36**h 220** 38  
**h 180** 44  
**h 140** 50**Informazioni tecniche** 58  
**Technical data**

**OT System.** Una collezione di piani di lavoro, contenitori e accessori che compongono le più svariate soluzioni, nel segno di una positiva essenzialità e vivibilità. Uno strumento universale e versatile, per pianificare e organizzare qualsiasi spazio operativo. **OT System.** A collection of work tops, storage units and accessories that can be configured in a wide variety of ways for positive simplicity and practicality. A universal and versatile tool for planning and organising any type of work space.

**OT System.** Eine Kollektion aus Arbeitsplatten, Schrankelementen und Zubehör, die unterschiedlichste Lösungen im Zeichen einer positiven Schlichtheit und Lebensqualität entstehen lassen. Vielseitig und anpassungsfähig, um jeden Arbeitsraum zu planen und zu organisieren. **OT System.** Une collection de plans de travail, de meubles de rangement et d'accessoires qui composent les solutions les plus variées, à l'enseigne d'une essentialité positive et vivable. Un instrument universel et flexible, pour planifier et organiser n'importe quel espace de travail.

**OT System.** Una colección de mesas de trabajo, módulos contenedores y accesorios que componen las soluciones más variadas, en el signo de una esencialidad y vivibilidad positiva. Un instrumento universal y versátil para planificar y organizar todo tipo de espacio operativo.

Quadra

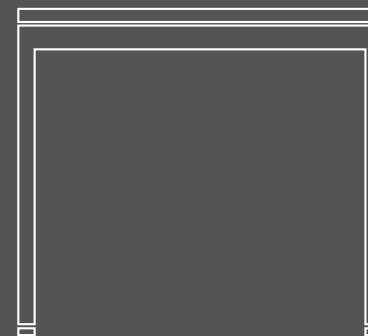

Round

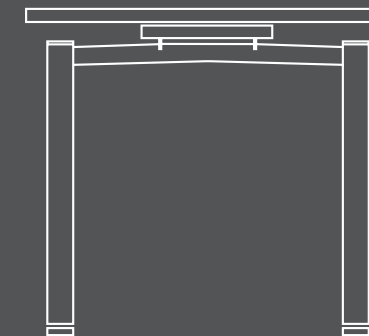

Mono "T"

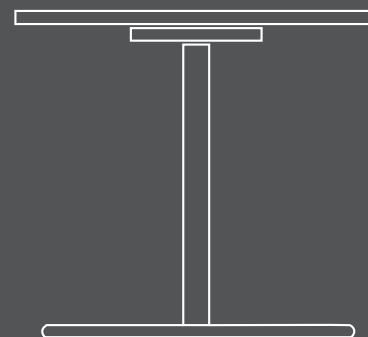

Mono "P"

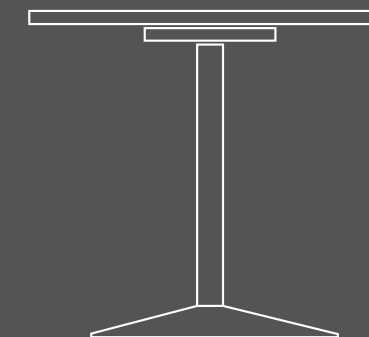





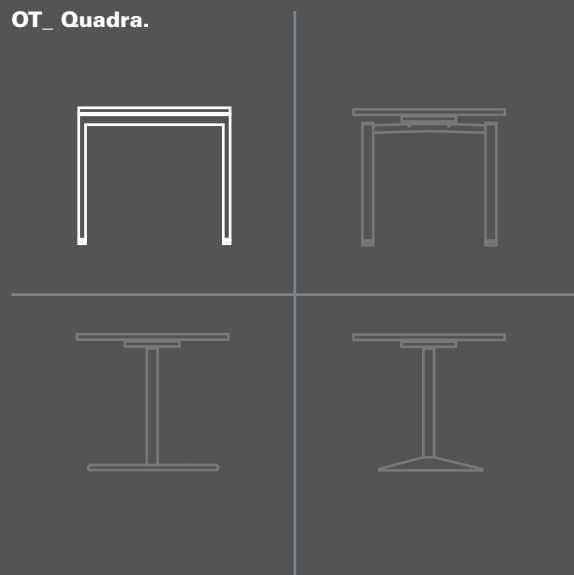

**OT + Quadra.** Con la massima semplicità ed efficacia, i tavoli con gambe a sezione quadra permettono di creare postazioni operative singole o multiple, liberamente strutturabili e personalizzabili. **OT + Quadra.** With maximum simplicity and effectiveness, these tables with square section legs can be used to create single or multiple work stations which can be freely structured and customised. **OT + Quadra.** Schlicht und wirkungsvoll lassen sich die Tische mit Füßen aus Vierkantrohr zu beliebigen Einzel- oder Mehrfacharbeitsplätzen mit individueller Ausstattung verbinden.

**OT + Quadra.** Avec le maximum de simplicité et d'efficacité, les tables munies de pieds de section carrée, permettent de créer des postes de travail individuels ou multiples, qui peuvent être structurés et personnalisés très librement. **OT + Quadra.** Con extrema simplicidad y eficacia, las mesas con patas de sección cuadrada permiten crear puestos de trabajo simples o múltiples, estructurados y personalizados libremente.





11 OT\_Quadra.



**Contenitori A**

Una serie completa di nuovi contenitori metallici affianca i tavoli, soddisfacendo qualsiasi necessità di archiviazione e contenimento. Il loro design essenziale, la finitura metallizzata e le stesse dimensioni permettono un perfetto accostamento con qualsiasi altro elemento di arredo.

**AC storage units.**

The tables are joined by a complete series of new metal storage units to meet any filing and storage needs. Their simple design and metallic finish, as well as their dimensions, allow them to combine perfectly with any type of furnishing units.

**Schränkelemente AC.**

Eine komplette Serie neuer Schränkelemente aus Metall ergänzt die Tische und schafft genügend Platz für Archive und sonstige Ablagen. Schlichtes Design, metallisierte Flächen und gleiche Abmessungen sorgen für ein perfektes Zusammenspiel mit allen anderen Einrichtungselementen.

**Meubles de rangement AC.**

Une série complète de nouveaux meubles métalliques complète les bureaux en répondant à toutes les exigences de classement et de rangement. Leur design essentiel, leur finition métallisée et leurs dimensions permettent de les assortir à n'importe quel autre type de mobilier.

**Módulos contenedores AC.**

Una serie completa de nuevos módulos contenedores metálicos a juego con las mesas satisfacen plenamente cualquier exigencia de archivo y contención. Su diseño esencial, el acabado metalizado y las mismas medidas permiten una combinación perfecta con cualquier otro elemento decorativo.



#### Stimolanti qualità.

Le cassettiere verticali dotate di ruote possono essere spostate a piacimento e si presentano in tipologie diverse, per soddisfare qualsiasi esigenza: dall'archivio al minibar. I cassetti, con presa laterale, sono privi di maniglie visibili, la verniciatura a polveri epossidiche ad alta resistenza è completata con uno speciale trattamento superficiale contro le impronte delle dita.

#### Stimulating qualities.

These tall drawer boxes on casters can be moved around as desired and are available in different versions to meet any requirement: from filing to minibar. The side-grip drawers have no visible handles. The tough epoxy powder paint finish includes a special treatment that prevents finger marks being left on the surface.

#### Stimulierende Qualitäten.

Die mit Rollen ausgestatteten, vertikalen Ladenschränke sind beliebig verschiebbar und werden allen Anforderungen gerecht: vom Archiv bis zur Minibar. Die Laden, mit seitlicher Bedienung, haben keine sichtbaren Griffe. Die hochbeständige Epoxy-Beschichtung ist mit einer speziellen Ausrüstung gegen unschöne Fingerabdrücke versehen.



#### Qualités stimulantes.

Les caissons verticaux sur roues peuvent être déplacés à volonté et sont disponibles en plusieurs typologies pour assurer des fonctions diverses : de l'archivage au mini-bar. Les tiroirs, avec prise latérale, sont sans poignées visibles. La finition laquée époxy haute résistance est complétée par un traitement superficiel contre les traces de doigts.

#### Cualidades estimulantes.

Las cajoneras verticales con ruedas pueden ser desplazadas a voluntad y se presentan en versiones diferentes, para satisfacer cualquier exigencia: del archivo al minibar. Los cajones, de agarre lateral, no tienen asas visibles. La pintura con polvos epoxídicos de elevada resistencia se completa con un tratamiento superficial especial contra las huellas dejadas por los dedos.









17 OT\_Quadra.



**Funzionalità di base.**

Tutti i piani sono dotati di monorotaie che permettono l'aggancio delle diverse basi e piantane oppure, in alternativa, di un mobile portante, disponibile anch'esso in diverse dimensioni e tipologie: con vani a giorno, cassetti e portacomputer.

**Base functions.**

All the work tops are equipped with single-track rails for attachment of the various bases and pedestals or, alternatively, with a supporting unit, also available in different sizes and versions: with open compartments, drawers and computer stand.

**Auf der Basis von Funktionalität.**

Alle Platten sind mit Einfachschienen ausgestattet, um verschiedene Unter- und Fußgestelle oder in Alternative ein tragendes Möbelement einhängen zu können, das ebenfalls in diversen Maßen und Ausführungen angeboten wird: mit offenen Fächern, Schubladen und Computerauflage.

**Fonctions de base.**

Tous les plans sont équipés de monorails qui permettent l'accrochage des différents piétements et montants ou bien, en alternative, d'un meuble porteur, disponible lui aussi en différentes dimensions et typologies : avec compartiment sans porte, tiroirs et logement pour unité centrale.

**Funcionalidad básica.**

Todas las tapas de las mesas están provistas de monorrailes que facilitan el enganche de las distintas bases y apoyos, o también, en alternativa, de un mueble de soporte, disponible también en distintas medidas y versiones: con espacios sin puertas, cajones y porta-ordenador.

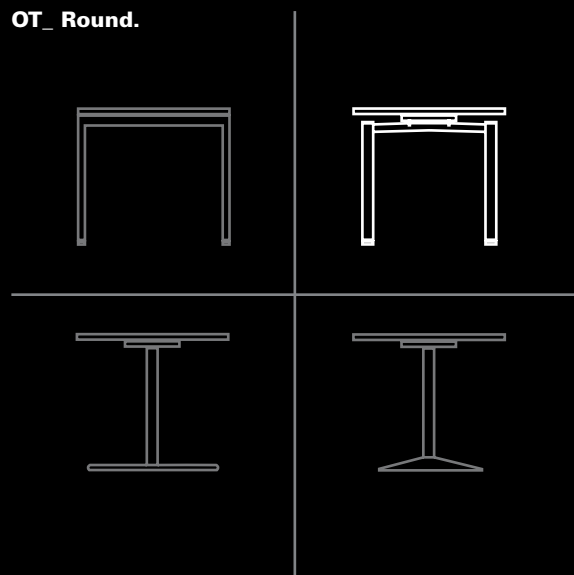

**OT + Round.** Grazie al sistema a monorotaia di cui sono dotati, tutti i piani della collezione possono essere completati con le gambe della serie Mèta, caratterizzate dalla sezione tonda e unite da un agile elemento ad arco. **OT + Round.** Due to the single-track rail system with which they are equipped, all the work tops in the collection can also be fitted with legs from the Mèta series, which have a round section and are joined by a slender, curved cross-member. **OT + Round.** Dank der Ausstattung mit Einzelschienen können für alle Platten der Kollektion Füße der Serie Mèta montiert werden: charakteristisch der runde Querschnitt und das schlanke, bogenförmige Element, mit dem sie verbunden sind.

**OT + Round.** Grâce au système de monorail dont ils sont équipés, tous les plans de la collection peuvent être complétés par les pieds de la série Mèta, caractérisés par la section ronde et un élément de raccord courbe. **OT + Round.** Gracias al sistema monorraíl con el que están equipadas, todas las mesas de la colección pueden completarse con patas de la serie Mèta, caracterizadas por su sección redonda y unidas por un ágil elemento arqueado.









**Libertè di  
accostamento.**

I tavoli possono essere affiancati da una scelta completa di contenitori con o senza ruote, con cassetti e vani a giorno, di diverse altezze e dimensioni, disponibili nelle medesime finiture grigio nebbia e rovere sbiancato dei piani di lavoro.

**Freedom of  
combination.**

The tables can be combined with a wide choice of storage units with or without casters, with drawer boxes and with open units in various heights and sizes, available in the same misty grey and bleached oak finishes as the work tops.

**Freiheit der  
Kombination.**

Die Tische können durch eine komplette Auswahl an Schrankelementen - mit oder ohne Rollen, mit Schubladen und offenen Fächern, in verschiedenen Höhen und Maßen - ergänzt werden, die wie die Arbeitsplatten in den Ausführungen Nebelgrau und gebleichte Eiche erhältlich sind.

**Liberté d'assortiment.**

Les tables peuvent être associées à une vaste gamme de meubles avec ou sans roues, à tiroirs ou sans portes, de différentes hauteurs et dimensions, disponibles dans les mêmes finitions que les plans de travail : gris brouillard et chêne blanchi.

**Libertad de  
combinación.**

Las mesas pueden presentarse junto con un surtido completo de módulos contenedores con o sin ruedas, con cajones y espacios sin puertas, de distintas alturas y dimensiones, disponibles en los mismos acabados de las tapas de las mesas: gris niebla y roble decapé.







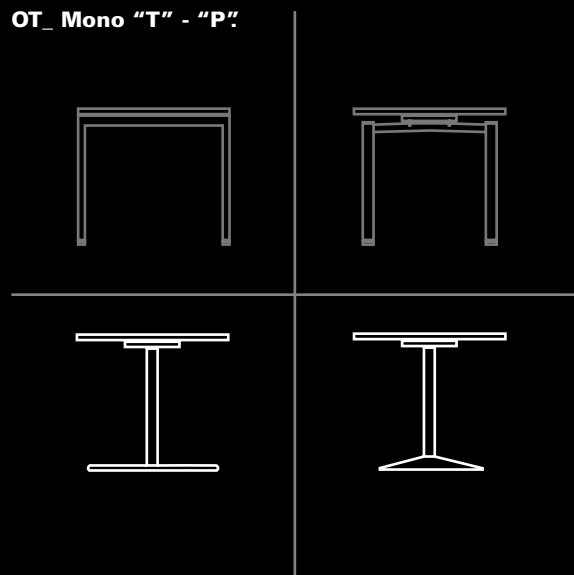

**OT + Mono.** Le possibilità si moltiplicano: al sistema a monorotaia possono essere agganciate anche le basi Mono "T" e Mono "P" che caratterizzano i sistemi Mèta e 3.Tre, mentre i piani si presentano con forme diverse, in un gioco di simmetrie e asimmetrie, rette e curve. **OT + Mono.** Possibilities are further increased: the single-track rail system can also be used for attaching Mono "T" and Mono "P" bases from the Mèta and 3.Tre systems, while tops are available in different shapes, symmetrical and asymmetrical, straight and curved. **OT + Mono.** Die Möglichkeiten vervielfachen sich: in den Schienen können auch die Untergestelle Mono "T" und Mono "P" eingehängt werden, die für die Linien Mèta und 3.Tre charakteristisch sind, während sich die Platten in diversen Formen, in einem Spiel aus Symmetrien und Asymmetrien, geraden und gebogenen Linien, präsentieren können. **OT + Mono.** Les possibilités se multiplient : au système à monorail on peut accrocher aussi les piétements Mono "T" et Mono "P" qui caractérisent les systèmes Mèta et 3.Tre, tandis que les plans se présentent avec des formes diverses, dans un jeu de symétries et d'asymétries, de lignes droites et courbes. **OT + Mono.** Las posibilidades se multiplican: en el sistema de monorraíl se pueden enganchar también las bases de apoyo Mono "T" y Mono "P" que caracterizan los sistemas Mèta y 3.Tre, mientras que las tapas presentan formas distintas, en un juego de simetrías y asimetrías, rectas y curvas.





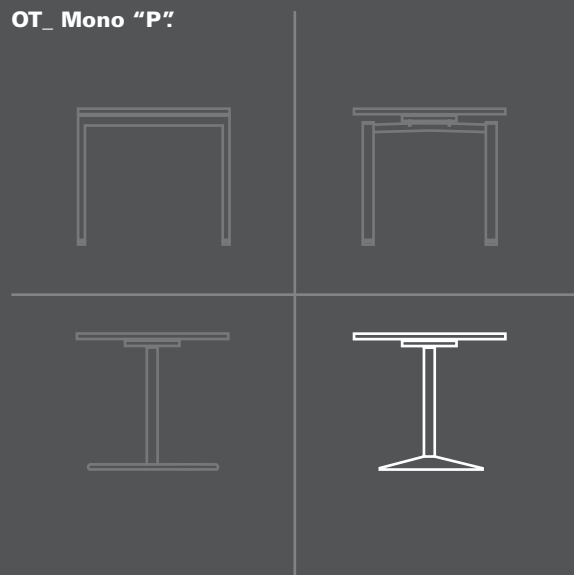

**Comporre lo spazio.**

Piani di lavoro, strutture portanti, mobili e accessori diventano elementi d'architettura interna, in perfetta sintonia con le altre serie Fantoni: dalle librerie fisse e su ruote, alle sedute operative e direzionali.

**Configuring space.**

Work tops, support structures, units and accessories become components for interior architectural design, in perfect tune with the other Fantoni ranges: from bookcases - fixed or on wheels - to operator and executive chairs.

**Den Raum gestalten.**

Arbeitsplatten, tragende Strukturen, Möbel und Zubehör werden zu Elementen der Innenarchitektur und sind perfekt auf die anderen Möbel der Kollektionen von Fantoni abgestimmt: Bücherschränke, fix oder auf Rollen, Büro- und Direktionsstühle.

**Composer l'espace.**

Les plans de travail, les structures portantes, les meubles et les accessoires deviennent des éléments d'architecture interne qui s'harmonisent parfaitement avec les autres séries Fantoni : des bibliothèques fixes et sur roues aux sièges secrétariat et direction.

**Componer el espacio.**

Las mesas, las estructuras de soporte, los muebles y accesorios se convierten en elementos de arquitectura de interiores, en perfecta sintonía con las otras series producidas por Fantoni: de las librerías fijas y sobre ruedas, a las sillas operativas y de dirección.



**Basi concettuali.**

Insieme alla forma del piano, la scelta della base determina la personalità di ogni singolo tavolo. Il sostegno a disco è derivato dalla serie Mèta, mentre le basi "T" e "P" sono un elemento caratterizzante della serie 3.Tre. In entrambi i casi la finitura prevista è un brillante argento metallizzato.

**Conceptual bases.**

Together with the shape of top, the choice of base establishes the personality of each individual table. The disc-shaped support derives from the Mèta series, while the "T" and "P" bases are characteristic of the 3.Tre series. Both feature a shiny metallic silver finish.

**Ausschlaggebend die Basis.**

Wie die Form der Platten, ist auch die Wahl der Untergestelle entscheidend für die Persönlichkeit der Tische. Der Ständer mit runder Platte stammt von der Serie Mèta, während die Gestelle "T" und "P" ein charakteristisches Element der Serie 3.Tre sind. In beiden Fällen ist die Farbe ein brillantes Silbergrau metallisiert.

**Piètements conceptuels.**

Avec la forme du plan, le choix du piétement détermine la personnalité de chaque bureau. La base circulaire dérive de la série Mèta, tandis que les piétements "T" et "P" sont un élément caractérisant de la série 3.Tre. Dans les deux cas, la finition prévue est argent métallisé brillant.

**Bases conceptuales.**

Junto con la forma de la tapa, la elección de la base determina la personalidad de cada una de las mesas. El apoyo en forma de disco deriva de la serie Mèta, mientras que las bases en "T" y "P" son elementos que caracterizan la serie 3.Tre. En ambos casos el acabado previsto es de color plata metalizado brillante.



**OT Unit System.** Più che un nuovo sistema operativo, un nuovo modo di costruire il proprio spazio. Elementi che definiscono ambienti, oltre ad essere strumenti di lavoro. Partendo da zero e arrivando a soluzioni sempre diverse, in continuo cambiamento. **OT Unit System.** More than a new office system, a new way of building your own space. Units that define the limits of working environments, as well as being working tools. Starting from zero to arrive at solutions that are always different, ever changing. **OT Unit System.** Mehr als ein neues, operatives System ist es eine neue Art, den eigenen Raum zu konstruieren. Elemente sind nicht nur Arbeitsinstrumente, sondern definieren auch den Raum. Ausgehend von Null, werden im ständigen Wechsel immer andere Lösungen erzielt. **OT Unit System.** Plus qu'un nouveau système de bureaux pour la zone secrétariat, c'est une nouvelle manière de construire l'espace de chaque utilisateur. Des éléments qui définissent des environnements, en plus d'être des instruments de travail. En partant de zéro et en arrivant à des solutions toujours différentes, en perpétuelle évolution.

**OT Unit System.** No se trata simplemente de un nuevo sistema operativo sino de una nueva manera de construir el propio espacio. Elementos que definen los ambientes y son también instrumentos de trabajo. Partiendo de cero y llegando a soluciones siempre diferentes, que cambian continuamente.



h 220



h 180



h 140

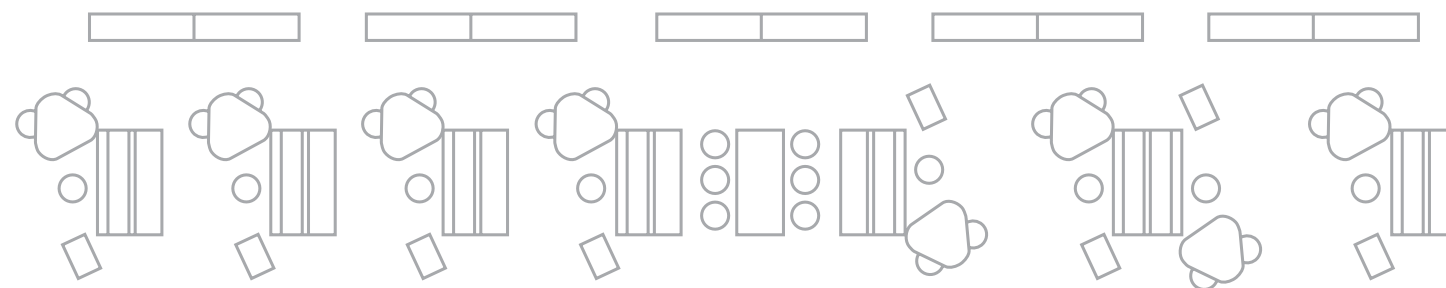

**Lo spazio di lavoro.**

Lo spazio di lavoro può essere personalizzato in tutti i sensi. Operative Wall è un posto di lavoro e un modulo divisorio allo stesso tempo. Operative Box è un versatile modulo di contenimento e suddivisione. Entrambi sono attrezzabili in più modi e componibili in diverse altezze.

**The work space.**

The work space can be personalised in all senses. Operative Wall is a work station and a partition module at the same time. Operative Box is a versatile storage and partition module. Both can be equipped in various ways and configured in different heights.

**Der Arbeitsraum.**

Der Arbeitsraum kann in jeder Hinsicht persönlich gestaltet werden. Operative Wall ist ein Arbeitsplatz und gleichzeitig ein Raumteilermodul. Operative Box ist ein flexibles Schrank- und Raumteilungsmodul. Beide können variabel ausgestattet und zu diversen Höhen kombiniert werden.

**L'espace de travail.**

L'espace de travail peut être personnalisé dans tous les sens. Operative Wall est un poste de travail et un module de division en même temps. Operative Box est un module de rangement et de subdivision polyvalent. Les deux peuvent être équipés de plusieurs manières et sont composables en différentes hauteurs.

**El espacio de trabajo.**

El espacio de trabajo puede ser personalizado en todos los sentidos. Operative Wall es un puesto de trabajo y al mismo tiempo un módulo divisorio. Operative Box es un módulo polivalente componible y de compartimentación. Las dos versiones se proponen en distintas soluciones y en varias alturas.



**Design e comunicazione.**

Il modulo operativo è bifacciale: entrambi i lati possono ospitare una diversa postazione di lavoro. La parte superiore del modulo può essere personalizzata graficamente.

**Design and communication.**

The operator module is two-sided: each side can be equipped for a different workstation. The upper part of the module can be decorated with customised graphics.

**Design und Kommunikation.**

Das operative Modul ist beidseitig: jede Seite kann einen anderen Arbeitsplatz aufnehmen. Das Modul kann an der Oberseite mittels Graphik individuell gestaltet werden.

**Design et communication.**

Le module de travail est biface : les deux côtés peuvent accueillir un poste de travail différent. La partie supérieure du module peut être personnalisée graphiquement.

**Diseño y comunicación.**

El módulo operativo presenta dos frentes: ambos lados pueden crear un puesto de trabajo diferente. La parte superior del módulo puede ser personalizada gráficamente.



**Scelte personali.**

Disponibile in diverse forme e colori, il tavolo di servizio è concepito come una parte integrante del posto di lavoro e, nel medesimo tempo, come un elemento indipendente: nell'utilizzo e nella collocazione.

**Personal choices.**

Available in different shapes and colours, the service table is designed as an integral part of the work station and, at the same time, as an independent unit: in terms of use and positioning.

**Eine individuelle Entscheidung.**

Der Beistelltisch, der in verschiedenen Formen und Farben erhältlich ist, kann sowohl als integrierter Bestandteil des Arbeitsplatzes als auch als selbständiges Element eingesetzt werden, in der Anwendung und in der Anordnung.

**Choix personnels.**

Disponibile en différentes formes et couleurs, la table de service est conçue comme une partie intégrante du poste de travail et, en même temps, comme un élément indépendant, tant du point de vue de l'utilisation que du positionnement.

**Decisiones personales.**

Disponibile en distintas formas y colores, la mesa de servicio está concebida como una parte integrante del puesto de trabajo y, al mismo tiempo, como un elemento independiente por uso y ubicación.



**Ambienti mobili.**

Operative Wall permette di operare in autonomia, offrendo a ognuno il giusto spazio e gli strumenti più adatti. Il pensile per l'archiviazione è disponibile con anta scorrevole o con vani a giorno.

**Mobile environments.**

Operative Wall allows people to work independently, providing each person with the right amount of space and the most suitable tools. Suspended filing cabinets are available with sliding door, or open-fronted.

**Mobile Räume.**

Operative Wall ermöglicht selbstständiges Arbeiten, da jeder den genau richtigen Raum und die geeigneten Instrumente zur Verfügung hat. Der Hängeschrank für Ablagen ist mit Schiebetür oder offenen Abteilen erhältlich.

**Espaces mobiles.**

Operative Wall permet d'opérer en toute autonomie, en offrant à chacun l'espace qui convient et les instruments les plus adaptés. L'élément d'archivage suspendu est disponible avec porte coulissante ou avec niches sans portes.

**Ambientes móviles.**

Operative Wall permite trabajar autónomamente, ofreciendo a cada uno el espacio apropiado y los instrumentos más idóneos. El elemento alto para el archivo está disponible con puerta corredera o con espacios sin puertas.



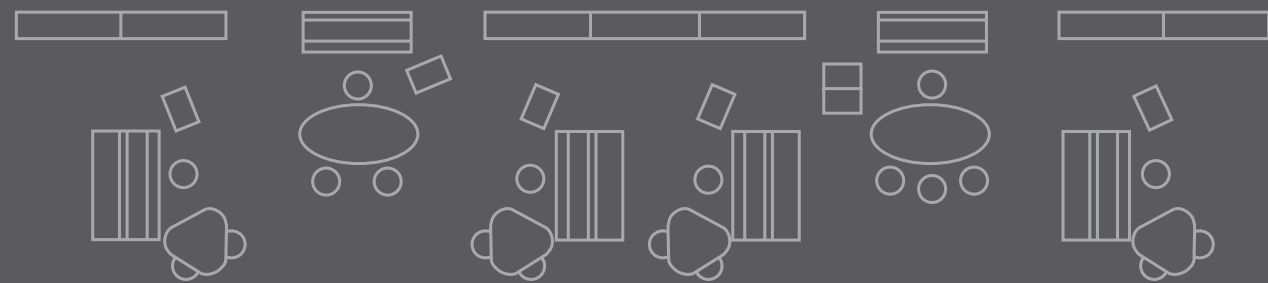

**Spazio variabile.**

Gli stessi elementi possono essere disposti e personalizzati in infiniti modi, creando delle stanze specifiche per ogni esigenza: dall'ufficio operativo alla sala meeting, dall'area per i colloqui con il pubblico all'archivio generale, e così via.

**Variable space.**

The same units can be arranged and personalised in an infinite variety of ways, creating specific rooms for every need: from working office to meeting room, from interview rooms to general filing areas, and so on.

**Variabler Raum.**

Die gleichen Elemente, auf verschiedenste Weise angeordnet bzw. individuell gestaltet, ergeben den passenden Raum für jeden Bedarf: operatives Büro, Bereiche für interne Meetings und Publikumsgespräch, allgemeines Archiv, etc.

**Espace variable.**

Les mêmes éléments peuvent être disposés et personnalisés de manières différentes, en créant des pièces spécifiques pour chaque exigence : du bureau secrétariat à la salle de réunion, de la zone d'accueil du public aux archives générales, et ainsi de suite.

**Espacio variable.**

Los mismos elementos pueden disponerse y personalizarse en infinitas versiones, creando ambientes específicos para cada exigencia: de la oficina operativa a la sala de reuniones, del área de atención al público al archivo general y así en más.





**Personalizzazione totale.**

Operative Wall può accogliere accessori diversi, ad altezze diverse: dal piano per il videoterminale, alla vaschetta portaoggetti, alla lampada alogena. La scrivania può essere rappresentata da un ampio tavolo indipendente, come nell'immagine a fianco.

**Total personalisation.**

Operative Wall can be fitted with a variety of accessories, at different heights: from monitor stand to storage tray, to halogen lamp. The desk can take the form of a large, free-standing table, as in the picture opposite.

**Persönliche Gestaltung.**

Operative Wall kann mit verschiedenen Accessoires in unterschiedlichen Höhen ausgestattet werden: Bildschirmunterlage, Halogenlampe. Als Schreibtisch dient beispielsweise ein großer, autonomer Tisch, wie das nebenstehende Foto zeigt.



**Personnalisation totale.**

Operative Wall peut accueillir des accessoires différents, à des hauteurs différentes : du plan pour le moniteur au bac porte-objets en passant par la lampe halogène. Le bureau peut être représenté par une grande table indépendante comme dans l'image ci-contre.

**Personalización total.**

Operative Wall puede recibir accesorios múltiples colocados a diversas alturas: del plano para el terminal vídeo, a la bandeja portaobjetos y a la lámpara halógena. El escritorio puede estar representado por una amplia mesa independiente, como la que se ilustra aquí al lado.



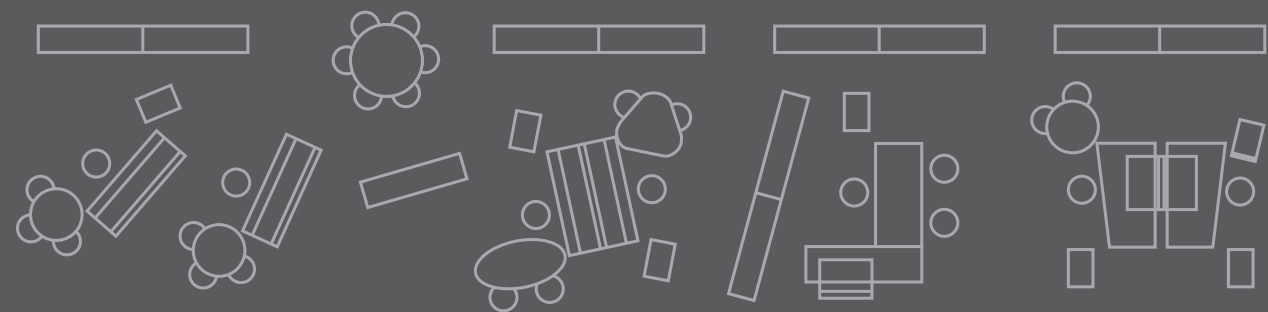

**Dinamiche interne.**

Oltre al modulo operativo, anche i contenitori e gli altri elementi possono muoversi su ruote: in questo modo, l'intera stanza può cambiare aspetto, ruolo e forma in pochi istanti.

**Interiors on the move.**

Like the operator module, the storage units and other units can be moved on casters: in this way, the appearance, function and shape of the entire room can be changed in just a few moments.

**Interne Dynamik.**

Nicht nur das operative Modul, auch Schränke und alle sonstigen Elemente sind auf Rollen beweglich: der ganze Raum kann in wenigen Augenblicken Optik, Funktion und Form verändern.

**Dynamiques internes.**

En dehors du module de travail, les armoires et les autres éléments peuvent être aussi sur roues: de cette manière, toute la pièce peut changer d'aspect, de rôle et de forme en quelques instants.

**Dinámicas interiores.**

No sólo el módulo operativo sino también los contenedores y los otros elementos pueden moverse sobre ruedas: de esta manera todo el entorno puede cambiar aspecto, función y forma en pocos instantes.





**Ambiente e colore.**

Un esempio di open space realizzato con gli elementi del sistema OT Unit System e caratterizzato dall'uso del colore.

**Surroundings and colour.**

Example of an open plan layout created with units from the OT Unit System and featuring the use of colour.

**Raum und Farbe.**

Beispiel für open space mit den Elementen von OT Unit System und charakteristischem Einsatz der Farben.

**Ambiance et couleur.**

Un exemple de bureau paysager réalisé avec les éléments du système OT Unit System et caractérisé par l'utilisation de la couleur.

**Entorno y color.**

Un ejemplo de espacio abierto realizado con los elementos del sistema OT Unit System y caracterizado por el uso del color.





#### Variazioni ulteriori.

L'aggregazione fra il modulo operativo "base", con funzione di supporto per il videoterminale, e il tavolo di servizio rettangolare, consente di creare un ampio e versatile posto di lavoro, singolo o doppio.



#### Room for later changes.

Combining the "basic" operator module, which acts as a support for the monitor, with a rectangular service table allows you to create a roomy and versatile, single or double workstation.



#### Weitere Alternativen.

Die Verbindung von operativem Grundmodul, das auch als Bildschirmunterlage dient, mit dem rechteckigen Beistelltisch, lässt einen großzügigen, vielseitigen Einzel- oder Doppelarbeitsplatz entstehen.



#### Variations ultérieures.

L'agrégation entre le module de travail de "base", avec fonction de support pour le moniteur, et la table de service rectangulaire, permet de créer un poste de travail spacieux et polyvalent, pour une ou deux personnes.



#### Otras variaciones.

La agregación entre el módulo operativo "básico" que sostiene el terminal vídeo y la mesa de servicio rectangular, permite crear un puesto de trabajo amplio y polivalente, simple o doble.





#### Fonti di energia.

I tavoli possono essere attrezzati con "Netbox": un sistema realizzato e distribuito dalla A. & H. Meyer per rendere disponibili, direttamente sul piano, le prese elettriche e telefoniche necessarie all'utilizzo di computer portatili o altre tecnologie di lavoro e comunicazione. Per ulteriori informazioni è possibile contattare direttamente l'Ufficio Tecnico Fantoni.

#### Sources of energy.

The tables can be equipped with "Netbox": a system made and distributed by the company A. & H. Meyer, to make power and telephone sockets - needed for using portable computers or other work and communication technologies - available on the desk top. For further information, please contact the Fantoni Design Office.

#### Quellen von Energie.

Die Tische können mit "Netbox" ausgestattet werden: ein von A. & H. Meyer entwickeltes und vertriebenes System, mit dem Steckdosen und Telefonanschlüsse für Laptop und andere Arbeits- und Kommunikationstechnologien direkt auf der Platte verfügbar sind. Für nähere Informationen wenden Sie sich bitte an die Technische Abteilung von Fantoni.

#### Sources d'énergie.

Les tables peuvent être équipées avec le système "Netbox", réalisé et distribué par A. & H. Meyer pour rendre disponibles, directement sur le plan, les prises électriques et téléphoniques nécessaires à l'utilisation d'ordinateurs portables ou d'autres technologies de travail et de communication. Pour tout renseignement supplémentaire, contacter directement le Bureau Technique Fantoni.

#### Fuentes de energía.

Las mesas pueden estar equipadas con "Netbox": un sistema realizado y distribuido por A. & H. Meyer que ponen directamente a disposición en la mesa, los enchufes eléctricos y tomas telefónicas necesarias para el uso de ordenadores portátiles u otras tecnologías empleadas en la actividad laboral y de comunicación. Para más información es posible contactar directamente con la Oficina Técnica Fantoni.



I piani per tavoli, disponibili in varie forme e misure sono dotati sottopiano di monorotaie standard, per l'aggancio di varie basi metalliche. I piani concepiti con la formula "universale" possono accogliere gambe delle **Collezioni OT, Mèta, 3.Tre** o qualsiasi mobile **portante**. Tutti i piani prevedono le finiture elencate e sono disponibili anche a misura (vedi capitolo OT del Listino generale Fantoni).

The table tops, available in various shapes and sizes, are fitted with single-track rails on the underside, as standard, for attachment of various metal bases. These "universal" tops can be equipped with legs from the **OT, Mèta and 3.Tre Collections**, or with any **supporting unit**. All the tops are available in the finishes listed and can also be supplied to measure (see OT section in the Fantoni general Price List).

Die in verschiedenen Formen und Maßen erhältlichen Tischplatten sind auf der Unterseite serienmäßig mit Einfachschiene ausgestattet, in die diverse Metallgestelle einhängbar sind. Die für "universale" Anwendung konzipierten Platten eignen sich für Füße der **Kollektionen OT, Mèta, 3.Tre** bzw. alle **tragenden Möbelemente**. Alle Platten sind in den angegebenen Farben erhältlich und auch nach Maß lieferbar (siehe Kapitel OT allgemeine Preisliste Fantoni).

Les plans des tables, disponibles en différentes formes et dimensions, sont équipés sur la face inférieure de monorails standard pour l'accrochage de différents piétements métalliques. Les plans conçus suivant la formule "universelle" peuvent être soutenus par des piétements des **Collections OT, Mèta, 3.Tre** ou n'importe quel meuble **porteur**. Tous les plans prévoient les finitions énumérées et sont disponibles aussi sur mesure (voir chapitre OT du Tarif général Fantoni).

Las tapas de las mesas, disponibles en distintas formas y medidas, están provistas con monorrailes estándar situados debajo del tablero, para enganchar las distintas bases metálicas. Las tapas diseñadas con la fórmula "universal" pueden incorporar patas de las **Colecciones OT, Mèta, 3.Tre** o cualquier otro mueble de **soporte**. Todas las tapas se proponen con los acabados indicados y son disponibles también a medida (ver capítulo OT del Catálogo general Fantoni).

Piano rettangolare, base **OT**  
Rectangular top, **OT** base  
Rechteckige Platte, Untergestell **OT**  
Plateau rectangulaire, piétement **OT**  
Tapa rectangular, base **OT**

Piano rettangolare, base **Mèta**  
Rectangular top, **Mèta** base  
Rechteckige Platte, Untergestell **Mèta**  
Plateau rectangulaire, piétement **Mèta**  
Tapa rectangular, base **Mèta**

Piano rettangolare, base **Mèta**  
Rectangular top, **Mèta** base  
Rechteckige Platte, Untergestell **Mèta**  
Plateau rectangulaire, piétement **Mèta**  
Tapa rectangular, base **Mèta**

Piano rettangolare, base **3.Tre**  
Rectangular top, **3.Tre** base  
Rechteckige Platte, Untergestell **3.Tre**  
Plateau rectangulaire, piétement **3.Tre**  
Tapa rectangular, base **3.Tre**

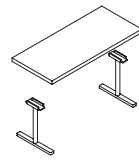
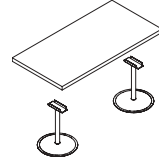
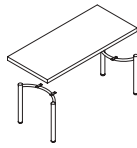
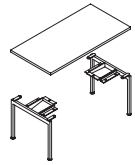

Piano asimmetrico, base **OT**  
Asymmetrical top, **OT** base  
Asymmetrische Platte, Untergestell **OT**  
Plateau asymétrique, piétement **OT**  
Tapa asimétrica, base **OT**

Piano sagomato, base **Mèta**  
Arc curved top, **Mèta** base  
Platte bogenförmig, Untergestell **Mèta**  
Plateau courbe, piétement **Mèta**  
Tapa curvada, base **Mèta**

Piano sagomato, base **Mèta**  
Arc curved top, **Mèta** base  
Platte bogenförmig, Untergestell **Mèta**  
Plateau courbe, piétement **Mèta**  
Tapa curvada, base **Mèta**

Piano sagomato, base **3.Tre**  
Arc curved top, **3.Tre** base  
Platte bogenförmig, Untergestell **3.Tre**  
Plateau courbe, piétement **3.Tre**  
Tapa curvada, base **3.Tre**

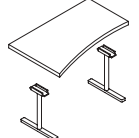
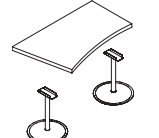
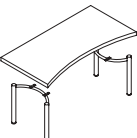
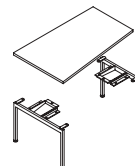

Piano ovale, base **Mèta**  
Oval top, **Mèta** base  
Ovale Platte, Untergestell **Mèta**  
Plateau ovale, piétement **Mèta**  
Tapa ovalada, base **Mèta**

Piano ovale, base **Mèta**  
Oval top, **Mèta** base  
Ovale Platte, Untergestell **Mèta**  
Plateau ovale, piétement **Mèta**  
Tapa ovalada, base **Mèta**

Piano ovale, base **3.Tre**  
Oval top, **3.Tre** base  
Ovale Platte, Untergestell **3.Tre**  
Plateau ovale, piétement **3.Tre**  
Tapa ovalada, base **3.Tre**

Piano ovale, con base portante  
Oval top, with supporting unit  
Ovale Platte, mit tragendem Element  
Plateau ovale, avec élément porteur  
Tapa ovalada, con base de soporte

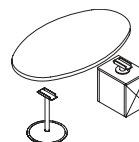
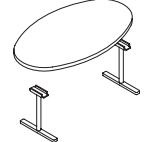
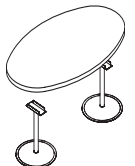

**OT**  
Piano rettangolare\_ Rectangular top\_Rechteckige Platte\_Plateau rectangulaire\_Tapa rectangular

P80  
**57-P808 L80 57-P812 L120**  
**57-P814 L140 57-P816 L160**  
**57-P818 L180 57-P820 L200**  
**57-P824 L240**

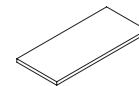

**OT**  
Piano rettangolare\_ Rectangular top\_Rechteckige Platte\_Plateau rectangulaire\_Tapa rectangular

P100  
**57-P826 L120 57-P827 L140**  
**57-P828 L160 57-P829 L180**  
**57-P830 L200 57-P831 L240**

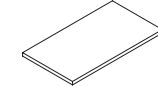

**OT**  
Piano asimmetrico (DX)\_ Asymmetrical top (RH)\_ Asymmetrische Platte (RE)\_ Plateau asymétrique (droit)\_ Tapa asimétrica (derecha)

P80-100  
**dx 57-P836 L160 sx 57-P837 L160**  
**dx 57-P838 L180 sx 57-P839 L180**  
**dx 57-P840 L200 sx 57-P841 L200**

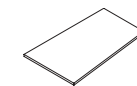

**OT**  
Piano dattilo\_ Typist's return unit\_Platte für Schreibplatz\_Plateau dactylo\_Tapa para mesa baja

P60  
**57-P908 L80 57-P910 L100**  
**57-P912 L120 57-P918 L180**  
**57-P920 L200**

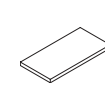

**OT**  
Piano ad arco (DX)\_ Arc curved top (RH)\_ Arbeitsplatte, bogenförmig (RE)\_ Plateau courbe (droit)\_ Tapa curvada (derecha)

P80-97  
**dx 57-P862 L160 sx 57-P863 L160**  
**dx 57-P866 L200 sx 57-P867 L200**

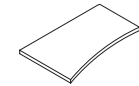

**OT**  
Piano asimmetrico (DX)\_ Asymmetrical top (RH)\_ Asymmetrische Arbeitsplatte (RE)\_ Plateau asymétrique (droit)\_ Tapa asimétrica (derecha)

P80-94,5  
**dx 57-P874 L160 sx 57-P875 L160**  
**dx 57-P878 L200 sx 57-P879 L200**

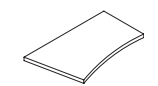

**OT**  
Piano simmetrico\_Symmetrical top\_Symmetrische Arbeitsplatte\_Plateau symétrique\_Tapa simétrica

P90-80  
**57-P888 L180**

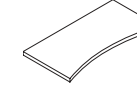

**OT**  
Piano ovale\_Oval top\_Ovale Platte\_Plateau oval\_Tapa ovalada

**57-P980 L180 P100 57-P981 L200 P120 57-P982 L240 P120**



**Mèta**  
Base fissa\_Table base\_Fußgestell für Tische\_Piètement pour tables\_Base para mesas

H72  
**53-BT21 L72**



**Mèta**  
Base regolabile\_Table base, adjustable height\_Fußgestell für Tische, höhenverstellbar\_Piètement pour tables, réglable\_Base para mesas, regulable

H68-82  
**53-BT23 L72**

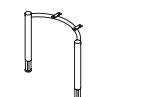

**Mèta**  
Base con ruote\_Table base, with casters\_Fußgestell für Tische, mit Rollen\_Piètement pour tables, avec roulettes\_Base para mesas, con ruedas

H72  
**53-BT25 L72**



**Mèta**  
Base fissa\_Table base\_Fußgestell für Tische\_Piètement pour tables\_Base para mesas

H72  
**53-BT33 L52**



**Mèta**  
Base regolabile\_Table base, adjustable height\_Fußgestell für Tische, höhenverstellbar\_Piètement pour tables, réglable\_Base para mesas, regulable

H68-82  
**53-BT38 L46**

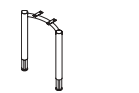

**Mèta**  
Base con disco\_Base with metal disc\_Fußgestell mit Fußplatte aus Metall\_Piètement avec base métallique ronde\_Base circular metálica

H72  
**53-BT53 Ø 45**

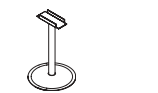

**Mèta**  
Base con disco\_Base with metal disc\_Fußgestell mit Fußplatte aus Metall\_Piètement avec base métallique ronde\_Base circular metálica

H72  
**53-BT54 Ø 57**

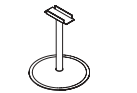

**Mèta**  
Base cilindrica con ruota\_Cylindrical base with caster\_Fußgestell aus Metallrohr mit Rolle\_Piètement cylindrique avec roulette\_Base cilindrica con rueda

H68  
**53-BT43 Ø 6**





<p><b>OT</b> Base fissa_Table base_Fußgestell für Tische_Piètement pour tables_Base para mesas</p>	<p><b>OT</b> Base regolabile_Table base, adjustable height_Fußgestell für Tische, höhenverstellbar_Piètement pour tables, réglable_Base para mesas, regulable</p>	<p><b>OT</b> Base fissa_Table base_Fußgestell für Tische_Piètement pour tables_Base para mesas</p>	<p><b>OT</b> Base regolabile_Table base, adjustable height_Fußgestell für Tische, höhenverstellbar_Piètement pour tables, réglable_Base para mesas, regulable</p>
<p>H72 <b>57-B801 P80</b></p>	<p>H68-82 <b>57-B803 P80</b></p>	<p>H72 <b>57-B807 P100</b></p>	<p>H68-82 <b>57-B809 P100</b></p>
<p><b>OT</b> Base fissa_Table base_Fußgestell für Tische_Piètement pour tables_Base para mesas</p>	<p><b>OT</b> Base regolabile_Table base, adjustable height_Fußgestell für Tische, höhenverstellbar_Piètement pour tables, réglable_Base para mesas, regulable</p>	<p><b>OT</b> Base fissa_Table base_Fußgestell für Tische_Piètement pour tables_Base para mesas</p>	<p><b>OT</b> Base regolabile_Table base, adjustable height_Fußgestell für Tische, höhenverstellbar_Piètement pour tables, réglable_Base para mesas, regulable</p>
<p>H72 <b>57-B901 P60</b></p>	<p>H68-82 <b>57-B903 P60</b></p>	<p>H72 <b>57-B821 P160</b> <b>57-B831 P200</b></p>	<p>H68-82 <b>57-B823 P160</b> <b>57-B833 P200</b></p>
<p><b>3.Tre</b> Base a T_T-shaped base_Fußgestell T-förmig_Piètement T_Base en forma de T</p>	<p><b>3.Tre</b> Base a T, regolabile_T-shaped base, adjustable height_Fußgestell T-förmig, höhenverstellbar_Piètement T, réglable Base en forma de T, regulable</p>	<p><b>3.Tre</b> Base a T_T-shaped base_Fußgestell T-förmig_Piètement T_Base en forma de T</p>	<p><b>3.Tre</b> Base a T, regolabile_T-shaped base, adjustable height_Fußgestell T-förmig, höhenverstellbar_Piètement T, réglable Base en forma de T, regulable</p>
<p>H72 <b>54-BA80 P68</b></p>	<p>H67-77 <b>54-BA90 P68</b></p>	<p>H72 <b>54-BA82 P50</b></p>	<p>H67-77 <b>54-BA92 P50</b></p>
<p><b>3.Tre</b> Base cilindrica_Cylindrical base Fußgestell aus Metallrohr_Piètement cylindrique_Base cilindrica</p>	<p><b>3.Tre</b> Base cilindrica, regolabile_Cylindrical base, adjustable height_Fußgestell aus Metallrohr, höhenverstellbar_Piètement cylindrique, réglable_Base cilindrica, regulable</p>	<p><b>OT</b> Cassettiera portante_Supporting drawer box_Tragender Schubladenkasten_Caisson porteur_Cajonera portante</p>	<p><b>OT</b> Cassettiera portante_Supporting drawer box_Tragender Schubladenkasten_Caisson porteur_Cajonera portante</p>
<p>H72 <b>54-BA84 Ø 6</b></p>	<p>H67-77 <b>54-BA94 Ø 6</b></p>	<p>H58 P60 <b>57-4911 L43</b></p>	<p>H58 P60 <b>57-4913 L43</b></p>

<p><b>OT</b> Mobile porta CPU, portante_Supporting CPU holder unit_Tragendes Computer-Möbel_Meuble porteur pour unité centrale_Mueble portante para unidad central</p>	<p><b>OT</b> Mobile con cassetti, portante_Supporting unit with drawers_Tragendes Möbel mit Schubladen_Meuble porteur avec tiroirs_Mueble portante con cajones</p>	<p><b>XL</b> Cassettiera portante_Supporting drawer box_Tragender Schubladenkasten_Caisson porteur_Cajonera portante</p>	<p><b>XL</b> Cassettiera portante_Supporting drawer box_Tragender Schubladenkasten_Caisson porteur_Cajonera portante</p>
<p>H58 P60 <b>57-4919 L33</b></p>	<p>H58 P60 <b>57-4927 L70</b></p>	<p>H58 P57 <b>58-8L23 L42</b></p>	<p>H58 P57 <b>58-8L24 L42</b></p>
<p><b>XL</b> Mobile porta CPU, portante_Supporting CPU holder unit_Tragendes Computer-Möbel_Meuble porteur pour unité centrale_Mueble portante para unidad central</p>	<p><b>XL</b> Mobile con cassetti, portante_Supporting unit with drawers_Tragendes Möbel mit Schubladen_Meuble porteur avec tiroirs_Mueble portante con cajones</p>	<p><b>3.Tre</b> Cassettiera portante_Supporting drawer box_Tragender Schubladenkasten_Caisson porteur_Cajonera portante</p>	<p><b>3.Tre</b> Cassettiera portante_Supporting drawer box_Tragender Schubladenkasten_Caisson porteur_Cajonera portante</p>
<p>H58 P57 <b>58-8L25 L32</b></p>	<p>H58 P57 <b>58-8L27 L70</b></p>	<p>H58 P57 <b>54-6A84 L42</b></p>	<p>H58 P57 <b>54-6A85 L42</b></p>
<p><b>3.Tre</b> Mobile porta CPU, portante_Supporting CPU holder unit_Tragendes Computer-Möbel_Meuble porteur pour unité centrale_Mueble portante para unidad central</p>	<p><b>OT</b> Piano rettangolare, base <b>OT</b> Rectangular top, <b>OT</b> base Rechteckige Platte, Untergestell <b>OT</b> Plateau rectangulaire, piètement <b>OT</b> Tapa rectangular, base <b>OT</b></p>	<p><b>OT</b> Piano rettangolare, base <b>Mèta</b> Rectangular top, <b>Mèta</b> base Rechteckige Platte, Untergestell <b>Mèta</b> Plateau rectangulaire, piètement <b>Mèta</b> Tapa rectangular, base <b>Mèta</b></p>	<p><b>OT</b> Piano rettangolare, base <b>Mèta</b> Rectangular top, <b>Mèta</b> base Rechteckige Platte, Untergestell <b>Mèta</b> Plateau rectangulaire, piètement <b>Mèta</b> Tapa rectangular, base <b>Mèta</b></p>
<p>H58 P57 <b>54-6A10 L30</b></p>	<p><b>57-P816 L160 P80</b> <b>57-B802</b></p>	<p><b>57-P816 L160 P80</b> <b>53-BT22</b></p>	<p><b>57-P829 L180 P100</b> <b>53-BT54x 2</b></p>
<p><b>OT</b> Piano rettangolare, base <b>3.Tre</b> Rectangular top, <b>3.Tre</b> base Rechteckige Platte, Untergestell <b>3.Tre</b> Plateau rectangulaire, piètement <b>3.Tre</b> Tapa rectangular, base <b>3.Tre</b></p>	<p><b>OT</b> Piano asimmetrico (SX), base <b>OT</b> Asymmetrical top (LH), <b>OT</b> base Asymmetrische Arbeitsplatte (LI), Untergestell <b>OT</b> Plateau asymétrique (gauche), piètement <b>OT</b> Tapa asimétrica (izquierda), base <b>OT</b></p>	<p><b>OT</b> Piano ad arco (DX), base <b>3.Tre</b> Arc curved top (RH), <b>3.Tre</b> base Arbeitsplatte bogenförmig (RE), Untergestell <b>3.Tre</b> Plateau courbe (droit), piètement <b>3.Tre</b> Tapa curvada (derecha), base <b>3.Tre</b></p>	<p><b>OT</b> Piano asimmetrico (DX), base <b>Mèta</b> Asymmetrical top (RH), <b>Mèta</b> base Asymmetrische Arbeitsplatte (RE), Untergestell <b>Mèta</b> Plateau asymétrique (droit), piètement <b>Mèta</b> Tapa asimétrica (derecha), base <b>Mèta</b></p>
<p><b>57-P816 L160 P80</b> <b>54-BA81</b></p>	<p><b>57-P839 L180 P80-100 sx</b> <b>57-B812 sx +(57-4911)</b></p>	<p><b>57-P862 L160 P80-97 dx</b> <b>54-BA81</b></p>	<p><b>57-P874 L160 P80-94,5 dx</b> <b>53-BT54x 2</b></p>

**OT**  
Piano simmetrico, base **Mèta**  
Symmetrical top, **Mèta**  
base\_Symmetrische Arbeitsplatte,  
Untergestell **Mèta**\_Plateau symétrique,  
piétement **Mèta**\_Tapa simétrica, base  
**Mèta**

**57-P888 L180 P90-80**  
**53-BT22**

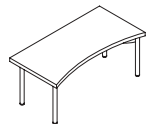

**OT**  
Piano asimmetrico (DX), base **Mèta**  
Asymmetrical top (RH), **Mèta** base  
Asymmetrische Arbeitsplatte (RE),  
Untergestell **Mèta**\_Plateau asymétrique  
(droit), piétement **Mèta**\_Tapa asimétrica  
(derecha), base **Mèta**

**57-P838 L180 P80-100 dx**  
**53-BT54 +(57-4911)**

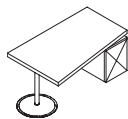

**OT**  
Piano asimmetrico (DX), base **3.Tre**  
Asymmetrical top (RH), **3.Tre** base  
Asymmetrische Arbeitsplatte (RE),  
Untergestell **3.Tre**\_Plateau asymétrique  
(droit), piétement **3.Tre**\_Tapa asimétrica  
(derecha), base **3.Tre**

**57-P838 L180 P80-100 dx**  
**54-BA80 +(57-4911)**

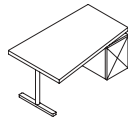

**OT**  
Piano ovale, base **Mèta**\_Oval top, **Mèta**  
base\_Ovale Platte, Untergestell  
**Mèta**\_Plateau oval, piétement **Mèta**\_Tapa  
ovalada, base **Mèta**

**57-P981 L200 P120**  
**53-BT54x 2**



**OT**  
Piano ovale, base **Mèta**\_Oval top, **Mèta**  
base\_Ovale Platte, Untergestell  
**Mèta**\_Plateau oval, piétement **Mèta**\_Tapa  
ovalada, base **Mèta**

**57-P981 L200 P120**  
**53-BT22**

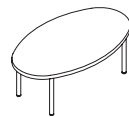

**OT**  
Piano ovale, base **3.Tre**\_Oval top, **3.Tre**  
base\_Ovale Platte, Untergestell  
**3.Tre**\_Plateau oval, piétement **3.Tre**\_Tapa  
ovalada, base **3.Tre**

**57-P981 L200 P120**  
**54-BA81**

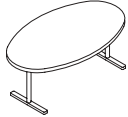

**OT**  
Piano ovale, base **Mèta**\_Oval top, **Mèta**  
base\_Ovale Platte, Untergestell  
**Mèta**\_Plateau oval, piétement **Mèta**\_Tapa  
ovalada, base **Mèta**

**57-P981 L200 P120**  
**53-BT54**



**OT**  
Piano simmetrico e piano tondo, basi  
**Mèta**\_Symmetrical and round top, **Mèta**  
bases\_Symmetrische und runde  
Arbeitsplatte, Untergestell **Mèta**\_Plateaux  
symétrique et ronde, piétement **Mèta**\_Tapa  
simétrica y redonda, base **Mèta**

**57-P888 L180 P90-80**  
**57-P983 Ø 90**  
**53-BT22 +53-BT44**



Tavolo rettangolare\_Rechteckiger  
Tisch\_Rectangular table Bureau  
rectangulaire\_Mesa rectangular

H72 P80  
**57-3808 L80** **57-3812 L120**  
**57-3814 L140** **57-3816 L160**  
**57-3818 L180** **57-3819 L200**  
**57-3822 L240**

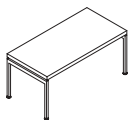

Tavolo rettangolare\_Rechteckiger  
Tisch\_Rectangular table Bureau  
rectangulaire\_Mesa rectangular

H72 P100  
**57-3811 L120** **57-3813 L140**  
**57-3815 L160** **57-3817 L180**  
**57-3821 L200** **57-3823 L240**

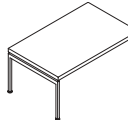

Tavolo rettangolare, regolabile\_Rectangular,  
adjustable table\_Rechteckiger Tisch,  
verstellbar\_Bureau rectangulaire,  
réglable\_Mesa rectangular, regulable

H62-82 P80  
**57-3831 L80** **57-3832 L120**  
**57-3834 L140** **57-3836 L160**  
**57-3838 L180** **57-3842 L200**  
**57-3844 L240**

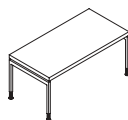

Tavolo rettangolare, regolabile\_Rectangular,  
adjustable table\_Rechteckiger Tisch,  
verstellbar\_Bureau rectangulaire,  
réglable\_Mesa rectangular, regulable

H62-82 P100  
**57-3833 L120** **57-3835 L140**  
**57-3837 L160** **57-3839 L180**  
**57-3843 L200** **57-3845 L240**

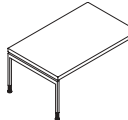

Tavolo rettangolare\_Rechteckiger  
Tisch\_Rectangular table Bureau  
rectangulaire\_Mesa rectangular

H72 P162,5  
**57-3872 L120** **57-3873 L140**  
**57-3874 L160** **57-3875 L180**  
**57-3876 L200** **57-3877 L240**

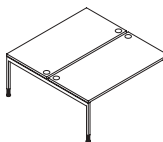

Tavolo rettangolare\_Rechteckiger  
Tisch\_Rectangular table Bureau  
rectangulaire\_Mesa rectangular

H72 P202,5  
**57-3878 L120** **57-3879 L140**  
**57-3880 L160** **57-3881 L180**  
**57-3882 L200** **57-3883 L240**

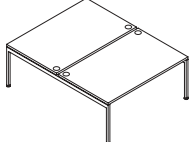

Tavolo asimmetrico\_Asymmetrical table  
Asymmetrischer Tisch\_Bureau  
asymétrique\_Mesa asimétrico

H72 P162,5- 202,5  
**57-3884 L160** **57-3885 L180**  
**57-3886 L200**

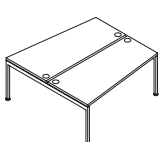

Tavolo rettangolare, regolabile\_Rectangular,  
adjustable table\_Rechteckiger Tisch,  
verstellbar\_Bureau rectangulaire,  
réglable\_Mesa rectangular, regulable

H62-82 P162,5  
**57-3892 L120** **57-3893 L140**  
**57-3894 L160** **57-3895 L180**  
**57-3896 L200** **57-3897 L240**

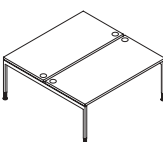

Tavolo rettangolare, regolabile\_Rectangular,  
adjustable table\_Rechteckiger Tisch,  
verstellbar\_Bureau rectangulaire,  
réglable\_Mesa rectangular, regulable

H62-82 P202,5  
**57-3898 L120** **57-3899 L140**  
**57-3900 L160** **57-3901 L180**  
**57-3902 L200** **57-3903 L240**

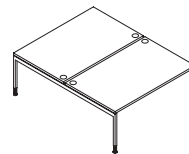

Tavolo asimmetrico,  
regolabile\_Asymmetrical, adjustable  
table\_Asymmetrischer Tisch,  
verstellbar\_Bureau asymétrique,  
réglable\_Mesa asimétrica, regulable

H62-82 P162,5- 202,5  
**57-3904 L160** **57-3905 L180**  
**57-3906 L200**

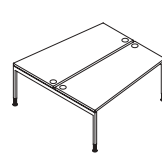

Pannello schermo in plexiglas\_Plexiglas  
screen panel\_Abschirmpaneel aus  
Plexiglas\_Panneau écran en  
plexiglas\_Panel separador en plexiglas

H39  
**57-S106 L60**  
**57-S108 L80**  
**57-S111 L110**

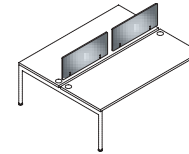

Pannello schermo in plexiglas\_Plexiglas  
screen panel\_Abschirmpaneel aus  
Plexiglas\_Panneau écran en  
plexiglas\_Panel separador en plexiglas

H39  
**57-S107 L70**

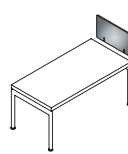

Piano sospeso girevole, in  
plexiglas\_Suspended swivel top,  
plexiglas\_Einhängbare Arbeitsplatte,  
drehbar, aus Plexiglas\_Plan suspendu  
pivotant, en plexiglas\_Mesa suspendida  
pivotante, plexiglas

Ø 60  
**57-P990**

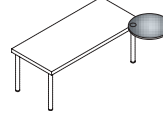

Pannello schermo in plexiglas\_Plexiglas  
screen panel\_Abschirmpaneel aus  
Plexiglas\_Panneau écran en  
plexiglas\_Panel separador en plexiglas

H39  
**57-S166 L60** **57-S168 L80**  
**57-S169 L90**

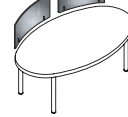

**XL**  
Contenitore a giorno\_Open  
cabinet\_Offener Schrank\_Armoire sans  
portes\_Armario sin puertas

L80 P47  
**58-9L41 H81,7** **58-9L51 H121,7**  
**58-9L61 H161,7** **58-9L71 H201,7**

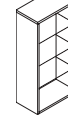

**XL**  
Contenitore ante legno\_Cabinet with  
wooden doors\_Schrank mit  
Holztüren\_Armoire portes bois\_Armario  
con puertas de madera

L80 P47  
**58-9L42 H81,7** **58-9L52 H121,7**  
**58-9L62 H161,7** **58-9L72 H201,7**



**XL**  
Contenitore ante vetro\_Cabinet with  
glass doors\_Schrank mit  
Glastüren\_Armoire portes  
vitrées\_Armario con puertas  
acristaladas

L80 P47  
**58-9L44 H81,7** **58-9L54 H121,7**  
**58-9L64 H161,7**

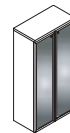

**XL**  
Contenitore ante scorrevoli\_Cabinet  
with sliding doors\_Schrank mit  
Schiebetüren\_Armoire portes  
coulissantes\_Armario con puertas  
correderas

L120 P47  
**58-9L81 H81,7** **58-9L86 H81,7**  
**58-9L82 H121,7** **58-9L87 H121,7**  
**58-9L83 H161,7** **58-9L88 H161,7**  
**58-9L84 H201,7**

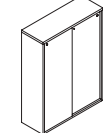

**3.Tre**  
Contenitore a giorno\_Open  
cabinet\_Offener Schrank\_Armoire sans  
portes\_Armario sin puertas

L90 P47  
**54-7A01 H81,7** **54-7A11 H121,7**  
**54-7A21 H161,7**

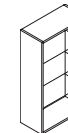

**3.Tre**  
Contenitore ante legno\_Cabinet with  
wooden door\_Armoire portes bois  
Schrank mit Holztüren\_Armario con  
puertas de madera

L90 P47  
**54-7A02 H81,7** **54-7A12 H121,7**  
**54-7A22 H161,7**

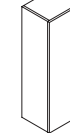

**3.Tre**  
Contenitore ante vetro\_Cabinet with glass  
doors\_Schrank mit Glastüren\_Armoire  
portes vitrées\_Armario con puertas  
acristaladas

L90 P47  
**54-7A03 H81,7** **54-7A13 H121,7**  
**54-7A23 H161,7**

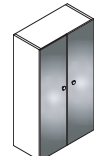

**3.Tre**  
Contenitore classificatore\_Filing  
cabinet\_Schrank für Aktenablage\_Armoire  
classeur\_Elemento con archivador

L90 P47  
**54-7A08 H81,7**

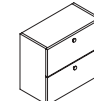

**OT**  
Elemento a giorno\_Open unit\_Offenes  
Element\_Élément sans portes\_Elemento  
sin puertas

H82+ 16  
**57-3412 L90 P35**  
**57-4412 L90 P45**







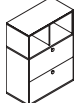
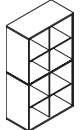
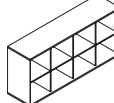
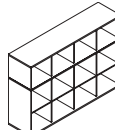

**OT**  
Elemento a giorno\_Open unit\_Offenes  
Element\_Élément sans portes\_Elemento  
sin puertas

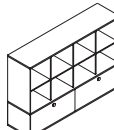
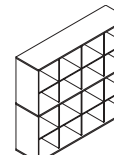
H122+ 16  
**57-3422 L90 P35**  
**57-4422 L90 P45**

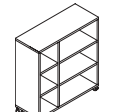





<p><b>OT</b> Elemento con classificatore_Filing unit_Element mit Aktenablage_Élément avec classeur_Elemento con archivador</p> <p>H122+ 16 <b>57-4423 L90 P45</b></p> 	<p><b>OT</b> Elemento a giorno_Open unit_Offenes Element_Élément sans portes_Elemento sin puertas</p> <p>H162+ 16 <b>57-3462 L90 P35</b> <b>57-4432 L90 P45</b></p> 	<p><b>OT</b> Elemento a giorno_Open unit_Offenes Element_Élément sans portes_Elemento sin puertas</p> <p>H82+ 16 <b>57-3462 L180 P35</b> <b>57-4462 L180 P45</b></p> 	<p><b>OT</b> Elemento a giorno_Open unit_Offenes Element_Élément sans portes_Elemento sin puertas</p> <p>H122+ 16 <b>57-3472 L180 P35</b> <b>57-4472 L180 P45</b></p> 
---	---	--	---

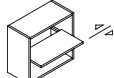
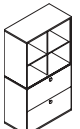
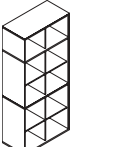
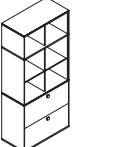

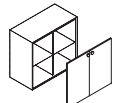
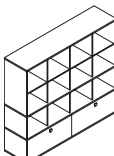
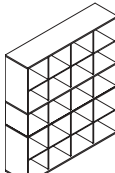
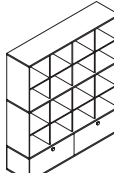

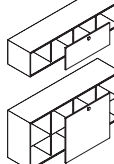
<p><b>OT</b> Elemento con classificatore_Filing unit_Element mit Aktenablage_Élément avec classeur_Elemento con archivador</p> <p>H122+ 16 <b>57-4473 L180 P45</b></p> 	<p><b>OT</b> Elemento a giorno_Open unit_Offenes Element_Élément sans portes_Elemento sin puertas</p> <p>H162+ 16 <b>57-3482 L180 P35</b> <b>57-4482 L180 P45</b></p> 	<p><b>XL</b> Elemento a giorno_Open unit_Offenes Element_Élément sans portes_Elemento sin puertas</p> <p>L160 P47 <b>58-8L40 H89</b></p> 	<p><b>XL</b> Elemento a giorno_Open unit_Offenes Element_Élément sans portes_Elemento sin puertas</p> <p>L120 P47 <b>58-8L41 H129</b></p> 
--	---	--	---





<p><b>XL</b> Elemento con classificatore_Filing unit_Element mit Aktenablage_Élément avec classeur_Elemento con archivador</p> <p>L80 P47 <b>58-9L46 H81,7</b></p> 	<p><b>XL</b> Elemento con classificatore_Filing unit_Element mit Aktenablage_Élément avec classeur_Elemento con archivador</p> <p>L80 P47 <b>58-9L48 H81,7</b></p> 	<p><b>3.Tre</b> Cassettiera mobile_Mobile drawer box_Beweglicher Schubladenkasten_Caisson mobile_Cajonera móvil</p> <p>L42 P57 <b>54-6A93 H108</b></p> 	<p><b>3.Tre</b> Mobile porta CPU_Free-standing computer stand_Freistehendes Computermöbel_Meuble autonome pour CPU_Mueble portaordenador autónomo</p> <p>L57 P57 <b>54-6A11 H58</b></p> 
--	--	--	---

<p><b>3.Tre</b> Contentore con ripiano estraibile_Cabinet with pull-out shelf_Schrank mit Ausziehplatte_Armoire avec tablette couissante_Armario con estante estraibile</p> <p>L90 P43 <b>54-7A50 H81,7</b></p> 	<p><b>OT</b> Elemento con classificatore_Filing unit_Element mit Aktenablage_Élément avec classeur_Elemento con archivador</p> <p>H162+ 16 <b>57-4433 L90 P45</b></p> 	<p><b>OT</b> Elemento a giorno_Open unit_Offenes Element_Élément sans portes_Elemento sin puertas</p> <p>H202+ 16 <b>57-3442 L90 P35</b> <b>57-4442 L90 P45</b></p> 	<p><b>OT</b> Elemento con classificatore_Filing unit_Element mit Aktenablage_Élément avec classeur_Elemento con archivador</p> <p>H202+ 16 <b>57-4443 L90 P45</b></p> 
---	---	---	---

<p><b>OT</b> Coppia ante_Pair of doors_1 Paar Türen_Jeu de 2 portes_Par de puertas</p> <p>H78 <b>57-3082 L90</b></p> 	<p><b>OT</b> Elemento con classificatore_Filing unit_Element mit Aktenablage_Élément avec classeur_Elemento con archivador</p> <p>H162+ 16 <b>57-4483 L180 P45</b></p> 	<p><b>OT</b> Elemento a giorno_Open unit_Offenes Element_Élément sans portes_Elemento sin puertas</p> <p>H202+ 16 <b>57-3492 L180 P35</b> <b>57-4492 L180 P45</b></p> 	<p><b>OT</b> Elemento con classificatore_Filing unit_Element mit Aktenablage_Élément avec classeur_Elemento con archivador</p> <p>H202+ 16 <b>57-4493 L180 P45</b></p> 
--	--	---	--

<p><b>OT</b> Anta scorrevole_Sliding door_Schiebetür_Porte couissante_Puerta corredera</p> <p>L90 <b>57-3070 H38</b> <b>57-3071 H78</b></p> 	<p><b>AC</b> Cassettiera su ruote_Schubladenkasten mit RollenDrawer box with casters_Caisson sur roulettes_Cajonera con ruedas</p> <p>H55,5 P53,5 <b>57-1C03 L42</b></p> 	<p><b>AC</b> Cassettiera su ruote_Schubladenkasten mit RollenDrawer box with casters_Caisson sur roulettes_Cajonera con ruedas</p> <p>H55,5 P53,5 <b>57-1C04 L42</b></p> 	<p><b>AC</b> Cassettiera su piedini_Drawer box with feet_Schubladenkasten mit Füßen_Caisson sur pieds_Cajonera con pies</p> <p>H69,3 P58,3 <b>57-1C21 L42</b></p> 
---	--	--	---

<p><b>AC</b> Cassettiera su piedini_Drawer box with feet_Schubladenkasten mit Füßen_Caisson sur pieds_Cajonera con pies</p> <p>H69,3 P58,3 <b>57-1C22 L42</b></p> 	<p><b>AC</b> Cassettiera su ruote_Schubladenkasten mit RollenDrawer box with casters_Caisson sur roulettes_Cajonera con ruedas</p> <p>H56,3 P78,1 <b>57-1C11 L43</b></p> 	<p><b>AC</b> Cassettiera su ruote_Schubladenkasten mit RollenDrawer box with casters_Caisson sur roulettes_Cajonera con ruedas</p> <p>H56,3 P78,1 <b>57-1C12 L43</b></p> 	<p><b>AC</b> Cassettiera su ruote_Schubladenkasten mit RollenDrawer box with casters_Caisson sur roulettes_Cajonera con ruedas</p> <p>H55,5 P53,3 <b>57-1C51 L60</b></p> 
---	--	--	--

<p><b>AC</b> Cassettiera su ruote_Schubladenkasten mit RollenDrawer box with casters_Caisson sur roulettes_Cajonera con ruedas</p> <p>H55,5 P53,3 <b>57-1C52 L60</b></p> 	<p><b>AC</b> Cassettiera su ruote, 6 cassetti_Drawer box with casters, 6 drawers_Schubladenkasten mit Rollen, 6 Laden_Caisson sur roulettes, 6 tiroirs_Cajonera con ruedas, 6 cajones</p> <p>H110 P53,3 <b>57-1C61 L42</b></p> 	<p><b>AC</b> Cassettiera su ruote, 5 cassetti_Drawer box with casters, 5 drawers_Schubladenkasten mit Rollen, 5 Laden_Caisson sur roulettes, 5 tiroirs_Cajonera con ruedas, 5 cajones</p> <p>H110 P53,3 <b>57-1C62 L42</b></p> 	<p><b>AC</b> Cassettiera su ruote, 2 cassetti_Drawer box with casters, 2 drawers_Schubladenkasten mit Rollen, 2 Laden_Caisson sur roulettes, 2 tiroirs_Cajonera con ruedas, 2 cajones</p> <p>H110 P53,3 <b>57-1C63 L42</b></p> 
--	--	--	--



**AC**  
Cassettiera su ruote, 3 cassetti\_Drawer box with casters, 3 drawers\_Schubladenkasten mit Rollen, 3 Laden\_Caisson sur roulettes, 3 tiroirs\_Cajonera con ruedas, 3 cajones

H110 P53,3  
**57-1C64 L42**



**AC**  
Server verticale per PC\_Unit for vertical PC tower\_Vertikaler Ständer für PC\_Pupitre vertical pour PC\_Servidor vertical para ordenador

H131,4 P57,9  
**57-1C71 L62,7**

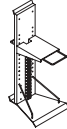

**AC**  
Box porta PC, su ruote disassate\_PC unit on offset casters\_Box für PC, auf außermittigen Rollen\_Box pour PC, sur roues désaxées\_Box para ordenador, sobre ruedas no alineadas

H61,5 P53,3  
**57-1C83 L32**



**AC**  
Ripiano a sbalzo per cassettiere, colore alluminio\_Projecting shelf for drawer boxes, aluminium colour\_Vorstehende Ablage für Container, aluminiumfarben\_Étagère en porte-à-faux pour caissons, couleur aluminium\_Estante en voladizo para cajoneras, color aluminio

P43  
**57-2C21 L40**

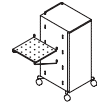

**AC**  
Top in laminato bianco e nero per cassettiere\_Black and white laminate top for drawer boxes\_Top aus weißem oder schwarzem Laminat für Container\_Dessus en stratifié blanc et noir pour caissons\_Tablero en laminado blanco y negro para cajoneras

P52  
**57-2C22 L41**

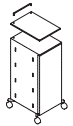

Composizione P2\_Configuration  
P2\_Zusammenstellung P2\_Composition  
P2\_Composición P2

H136 P67 L90  
**57-3152 + 57-3733 + 57-3713 + 57-3657**



Composizione P4\_Configuration  
P4\_Zusammenstellung P4\_Composition  
P4\_Composición P4

H176 P67 L90  
**57-3143 + 57-3642 + 57-3754 + 57-3657 + 57-3714**

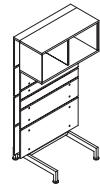

Composizione P5\_Configuration  
P5\_Zusammenstellung P5\_Composition  
P5\_Composición P5

H216 P67 L90  
**57-3144 + 57-3755 + 57-3715 + 57-3657**

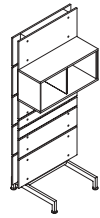

Composizione P11\_Configuration  
P11\_Zusammenstellung P11\_Composition  
P11\_Composición P11

H99 P98 L180  
**57-4146 + 57-4712 x2 + 57-3635**



Composizione P9\_Configuration  
P9\_Zusammenstellung P9\_Composition  
P9\_Composición P9

H176 P67 L180  
**57-3148 + 57-3647 + 57-4754 + 57-4714 + 57-3657 x2**

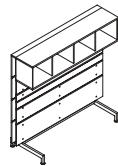

Composizione P10\_Configuration  
P10\_Zusammenstellung P10\_Composition  
P10\_Composición P10

H216 P67 L180  
**57-3149 + 57-4755 + 57-4715 + 57-3657 x2**

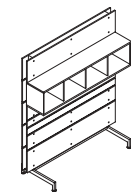

Composizione P19\_Configuration  
P19\_Zusammenstellung P19\_Composition  
P19\_Composición P19

H136 P121 L180  
**57-4157 + 57-4733 x2 + 57-3609 x2 + 57-3621 x2 + 57-3657 x2**

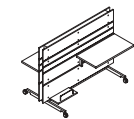

Composizione P17\_Configuration  
P17\_Zusammenstellung P17\_Composition  
P17\_Composición P17

H176 P121 L180  
**57-4148 + 57-3618 x2 + 57-4754 + 57-3657 x2 + 57-4734**

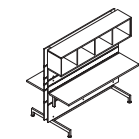

Elemento a giorno\_Open unit\_Offenes Element\_Élément sans portes\_Elemento sin puertas

H82 + 16  
**57-3412 L90 P35**  
**57-4412 L90 P45**

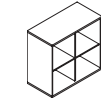

Elemento con classificatore (2 cass.)\_Filing unit (2 drawer)\_Element für Aktenablage (2 L.)\_Élément classeur (2 tir.)\_Elemento archivador (2 cajones)

H122 + 16 P45  
**57-4423 L90**



Elemento a giorno\_Open unit\_Offenes Element\_Élément sans portes\_Elemento sin puertas

H162 + 16  
**57-3432 L90 P35**  
**57-4432 L90 P45**

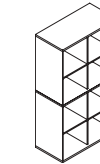

Elemento a giorno\_Open unit\_Offenes Element\_Élément sans portes\_Elemento sin puertas

H202 + 16  
**57-3442 L90 P35**  
**57-4442 L90 P45**

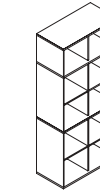

Coppia ante universali\_Pair of universal doors\_1 Paar Universaltüren\_Jeu de 2 portes universelles\_Par de puertas universales

H78 P2  
**57-3082 L90**

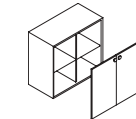

Anta scorrevole universale\_Universal sliding doors\_Universelle Schiebetür\_Porte coulissante universelle\_Puerta corredera universal

H38 P2  
**57-3070 L90**

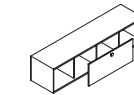

Anta scorrevole universale\_Universal sliding doors\_Universelle Schiebetür\_Porte coulissante universelle\_Puerta corredera universal

H78 P2  
**57-3071 L90**

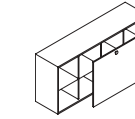

Basi per mobili\_Bases for units\_Unterbauten für Möbel\_Bases pour meubles\_Bases para muebles

H2  
H16

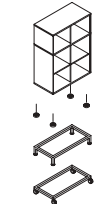

Composizione P12\_Configuration  
P12\_Zusammenstellung P12\_Composition  
P12\_Composición P12

H136 P98 L180  
**57-4157 + 57-4733 + 57-4713 + 57-3657 x2**



Composizione P13\_Configuration  
P13\_Zusammenstellung P13\_Composition  
P13\_Composición P13

H176 P98 L180  
**57-3148 + 57-4744 + 57-4714 + 57-3657 x2**

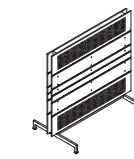

Composizione P14\_Configuration  
P14\_Zusammenstellung P14\_Composition  
P14\_Composición P14

H216 P90 L180  
**57-3149 + 57-3618 + 57-4715 + 57-4755**  
**57-3657 x2**

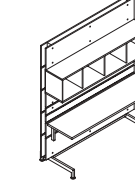

Composizione P15\_Configuration  
P15\_Zusammenstellung P15\_Composition  
P15\_Composición P15

H216 P121 L180  
**57-4149 + 57-4755 x2 + 57-3618 x2 + 57-3657 x2**

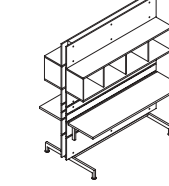

Composizione P20\_Configuration  
P20\_Zusammenstellung P20\_Composition  
P20\_Composición P20

H176 P121 L180  
**57-4148 + 57-3618 x2 + 57-4754 x2 + 57-3657 x2 + 57-3070 x2 + 57-3648**

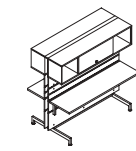

Composizione P32\_Configuration  
P32\_Zusammenstellung P32\_Composition  
P32\_Composición P32

H138 P67 L90  
**57-3162 + 57-3222 + 57-3642 + 57-3713**

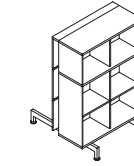

Composizione P34\_Configuration  
P34\_Zusammenstellung P34\_Composition  
P34\_Composición P34

H178 P67 L180  
**57-4714 + 57-3647 + 57-3168 + 57-3071 x2 + 57-4282**

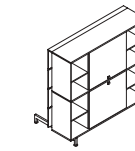

Composizione P35\_Configuration  
P35\_Zusammenstellung P35\_Composition  
P35\_Composición P35

H216 P67 L180  
**57-3169 + 57-4293 + 57-3647 + 57-4715**

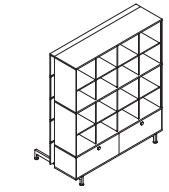

Elemento a giorno\_Open unit\_Offenes  
Element\_Élément sans porte\_Elemento  
sin puertas

H82 + 16  
**57-3462 L180 P35**  
**57-4462 L180 P45**

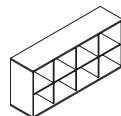

Elemento con classificatore (2 cass.)\_Filing  
unit (2 drawer)\_Element für Aktenablage  
(2 L.)\_Élément classeur (2 tir.)\_Elemento  
archivador (2 cajones)

H122 + 16 P45  
**57-4473 L180**

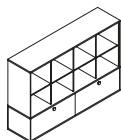

Elemento a giorno\_Open unit\_Offenes  
Element\_Élément sans porte\_Elemento  
sin puertas

H162 + 16  
**57-3482 L180 P35**  
**57-4482 L180 P45**

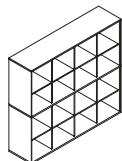

Elemento a giorno\_Open unit\_Offenes  
Element\_Élément sans porte\_Elemento  
sin puertas

H202 + 16  
**57-3492 L180 P35**  
**57-4492 L180 P45**

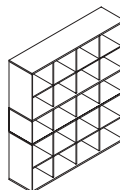

#### Finiture

Nell'ambito di ogni collezione non tutti gli articoli sono disponibili in tutti i colori elencati. I disegni riportati nelle "informazioni tecniche" del catalogo sono esemplificativi. Per una completa visione della disponibilità di colori e della totalità degli articoli è consigliata la consultazione del Catalogo Tecnico.

#### Finishes

Within each collection, not all articles are available in all the colours listed. The drawings in the "technical data" sections of the catalogue are only examples. To view the full range of colours and articles available, please consult the Technical Catalogue.

#### Farben

Nicht alle Artikel einer Kollektion sind in allen angeführten Farben erhältlich. Die im Katalog unter «technische Informationen» abgebildeten Zeichnungen sind nur eine Richtlinie. Detaillierte Informationen über die angebotenen Farben und alle Artikel entnehmen Sie bitte dem Technischen Katalog.

#### Finitions

À l'intérieur de chaque collection, tous les articles ne sont pas forcément disponibles dans toutes les couleurs énumérées. Les dessins figurant dans les « informations techniques » du catalogue sont indicatifs. Pour un panorama complet de la disponibilité de couleurs et de la totalité des articles, il est conseillé de consulter le Catalogue Technique.

#### Acabados

En cada colección, no todos los artículos están disponibles en los distintos colores indicados. Los dibujos ilustrados en las «informaciones técnicas» del catálogo son ejemplificadores. Para conocer la disponibilidad completa de los colores y de todos los artículos, se aconseja consultar el Catálogo Técnico.

#### Piani universali\_Table tops Tischplatten\_Plateaux\_Mesas

##### GN

Grigio nebbia\_Misty grey\_Nebelgrau  
Gris brouillard\_Gris niebla

##### RW

Melaminico rovere sbiancato\_Bleached  
oak melamine\_Melamin Eiche  
gebleicht\_Mélaminé chêne  
blanc\_Melaminico roble decapé

##### AR

Melaminico argento\_Silver  
melamine\_Melamin silbergrau  
Mélaminé argent\_Melaminico plata

#### Pannelli\_Panels\_Vertäfelung Panneaux\_Paneles

##### AR

Melaminico argento\_Silver  
melamine\_Melamin silbergrau  
Mélaminé argent\_Melaminico plata

##### QW

Melaminico bianco\_White melamine  
Melamin weiß\_Mélaminé  
blanc\_Melaminico blanco

##### QK

Melaminico nero\_Black melamine  
Melamin schwarz\_Mélaminé  
noir\_Melaminico negro

##### RD

Melaminico rosso\_Red melamine  
Melamin rot\_Mélaminé rouge  
Melaminico rojo

##### YW

Melaminico giallo\_Yellow melamine  
Melamin gelb\_Mélaminé  
jaune\_Melaminico amarillo

##### BL

Melaminico blu\_Blue melamine  
Melamin blau\_Mélaminé bleu  
Melaminico azul

##### GN

Grigio nebbia\_Misty grey\_Nebelgrau  
Gris brouillard\_Gris niebla

#### Mobili\_Units\_Meubles\_Möbel Muebles

##### AR

Melaminico argento\_Silver  
melamine\_Melamin silbergrau  
Mélaminé argent\_Melaminico plata

#### Contenitori\_Cabinets\_Armoires Schränke\_Armarios

##### AR

Melaminico argento\_Silver  
melamine\_Melamin silbergrau  
Mélaminé argent\_Melaminico plata

##### RW

Melaminico rovere sbiancato\_Bleached  
oak melamine\_Melamin Eiche  
gebleicht\_Mélaminé chêne  
blanc\_Melaminico roble decapé

##### GN

Grigio nebbia\_Misty grey\_Nebelgrau  
Gris brouillard\_Gris niebla

##### VV

Verde cedro\_Citron green\_Zederngrün  
Vert cèdre\_Verde cedro

##### GY

Giallo cromo\_Chrome yellow  
Chromgelb\_Jaune chrome  
Amarillo cromo

##### RR

Rosso lacca\_Lacquer red\_Lackrot  
Rouge laque\_Rojo laca

##### NF

Nobilitato faggio\_Melamine faced beech  
Melamin Buche\_Hêtre Mélaminé\_Haya  
melaminica

##### BE

Melaminico beige\_Beige melamine  
Melamin beige\_Mélaminé beige  
Melaminico beige

#### Cassettiere\_Drawerboxes\_Caissons Schubladienkästen\_Cajoneras

##### AR

Melaminico argento\_Silver  
melamine\_Melamin silbergrau  
Mélaminé argent\_Melaminico plata

##### GN

Grigio nebbia\_Misty grey\_Nebelgrau  
Gris brouillard\_Gris niebla

##### VV

Verde cedro\_Citron green\_Zederngrün  
Vert cèdre\_Verde cedro

##### NF

Nobilitato faggio\_Melamine faced beech  
Melamin Buche\_Hêtre Mélaminé\_Haya  
melaminica

##### GY

Giallo cromo\_Chrome yellow\_Chromgelb  
Jaune chrome\_Amarillo cromo

##### RR

Rosso lacca\_Lacquer red\_Lackrot  
Rouge laque\_Rojo laca

##### BE

Melaminico beige\_Beige melamine  
Melamin beige\_Mélaminé beige  
Melaminico beige

#### Cassettiere in metallo Metal drawer-boxes\_Caissons métalliques\_Metall-Container Cajoneras metálicas

##### AL

Verniciatura colore alluminio\_Aluminium  
paint finish\_Aluminiumfarben  
lackiert\_Peinture couleur  
aluminium\_Pintura color aluminio

## Fantoni around the world

### **Abruzzo, Molise, Umbria**

Chieti Tel. 085/4463707

### **Calabria**

Cosenza Tel. 0984/839183

### **Campania**

Napoli Tel. 081/682672

### **Emilia Romagna**

Bologna Tel. 051/226255

### **Friuli Venezia Giulia**

Udine Tel. 0432/237346

### **Lazio**

Roma Tel. 06/36001905

Frosinone, Latina Tel. 0775/201325

### **Liguria**

Genova, La Spezia Tel. 010/530921

Savona, Imperia Tel. 019/862112

### **Lombardia**

Milano, Lodi, Brescia

Tel. 02/58306069

Mantova, Cremona Tel. 0376/45077

Bergamo, Pavia Tel. 02/58018428

Varese, Como, Sondrio, Lecco

Tel. 348/2685359

### **Marche**

Ancona Tel. 071/7108816

### **Piemonte**

Torino Tel. 011/6813778

Cuneo Tel. 019/862112

### **Puglia e Basilicata**

Bari Tel. 080/5541072

Bari Tel. 080/3953860

### **Sardegna**

Cagliari Tel. 348/3315783

### **Sicilia**

Palermo, Trapani, Agrigento,

Caltanissetta Tel. 091/408522

Catania, Messina, Siracusa,

Ragusa, Enna Tel. 095/449665

### **Toscana**

Firenze, Prato, Pistoia,

Arezzo, Siena Tel. 055/340077

Massa Carrara, Lucca, Pisa,

Livorno, Grosseto Tel. 348/2878840

### **Trentino Alto Adige**

Padova Tel. 336/498421

### **Val d'Aosta**

Torino Tel. 011/6813778

### **Veneto**

Padova, Vicenza Tel. 049/8756766

Venezia, Rovigo Tel. 041/5209462

Treviso, Belluno Tel. 0423/737544

Verona Tel. 0376/671660

### **Australia**

Melbourne Tel. +613/9654/8522

Sydney Tel. +612/9690/0077

### **Austria**

Udine (Italy) Tel. +39/335/232834

### **Belgium**

Gent Tel. +32/9/2581470

### **Bosnia**

Ljubuski Tel. +387/39/833378

Sarajevo Tel. +387/33/444500

Udine (Italy) Tel. +39/0432/976222

### **Bulgaria**

Sofia Tel. +359/2/9516607

### **Canada**

Toronto Tel. +1/416/3641011 ext. 113

### **China**

Beijing Tel. +86/10/65470090

Shanghai

Tel. +86/21/62118571 ext 202

### **Corea**

Seoul Tel. +82/2/7633361

### **Croatia**

Zagreb Tel. +385/1/4922759

Udine (Italy) Tel. +39/0432/976222

### **Cyprus**

Nicosia Tel. +357/22/351366

### **Czech Republic**

Praha Tel. +420/2/22873209

Udine (Italy) Tel. +39/0432/976222

### **Denmark**

Odense Tel. +45/66117411

### **Finland**

Espoo Tel. +358/9/68030470

### **France**

Nord - Strasbourg Tel. +33/3/88234623

Sud - Albi Tel. +33/5/63773030

### **Germany**

Stuttgart Tel. +49/7125/407060

Berlin Tel. +49/30/33771212

Hamburg Tel. +49/40/894989

Düsseldorf Tel. +49/2161/2945910

München Tel. +49/89/6101977

### **Greece**

Athens Tel. +30/210/6842122

Thessaloniki Tel. +30/2310/463533-4

### **Indonesia**

Jakarta Tel. +62/21/533/2119

### **Israel**

Tel Aviv Tel. +972/3/6474465

### **Japan**

Tel. +81/335127534

Udine (Italy) Tel. +43/664/5419707

### **Latvia**

Riga Tel. +371/7242712

### **Lebanon**

Beiruth Tel. +961/1/360233

### **Liechtenstein**

Udine (Italy) Tel. +39/335/232834

### **Lithuania**

Vilnius Tel. +370/5/2600445

### **Lussemburgo**

Tel. +32/9/3830824

### **Mexico**

Mexico D.F. Tel. +52/52828959

### **Netherlands**

Waardenburg Tel. +31/418/654522

### **Norway**

Oslo Tel. +47/23133070

### **Poland**

Warszawa Tel. +48/22/3225000

Udine (Italy) Tel. +39/0432/976222

### **Puerto Rico**

Santurce Tel. +1/787/7281555

### **Portugal**

Lisbon Tel. 0035/1963022254

### **Rep. Dominicana**

Santo Domingo

Tel. +1809/4720022

### **Romania**

Udine (Italy) Tel. +39/0432/976222

### **Russia**

Moscow Tel. +7/95/1055055

Novosibirsk Tel. +7/3832/119393

S. Petersburg Tel. +7/812/5423433

Kazan Tel. +7/8432/414121

### **Slovakia**

Bratislava Tel. +4212/64461991

Udine (Italy) Tel. +39/0432/976222

### **Slovenia**

Ljubljana Tel. +386/1/4211464

Udine (Italy) Tel. +39/0432/976222

### **Spain**

Las Palmas Tel. +34/9/28368211

Madrid Tel. +34/91/4428411

San Sebastian Tel. +34/9/43444450

Tenerife Tel. +34/9/22249624

Valencia Tel. +34/96/3923527

### **Sweden**

Linkoping Tel. +46/13352400

### **Switzerland**

Zurich Tel. +41/1/2724442

### **Taiwan**

Taipei Tel. +886/22/5459191

### **Turkey**

Istanbul Tel. +90/212/2165320

### **Ungheria**

Udine (Italy) Tel. +39/335/1329026

### **United Kingdom**

Godalming, Surrey

Tel. +44/1483/527996

### **United Arab Emirates**

Dubai Tel. +971/50/5538122

### **Usa**

Bloomington Tel. +1/952/9446525

Chicago Tel. +1/312/6649582

Los Angeles +1/310/8587705

Miami Tel. +1/305/4487367

New York Tel. +1/212/2428887

San Francisco Tel. +1/415/5435466

Seattle Tel. +1/206/6222433

### **Venezuela**

Caracas Tel. +58/2/2677712

### **Yugoslavia**

Beograd Tel. +38/111/3037303

Fantoni Spa

I-33010 Osoppo / Udine

Telefono +39 0432 9761

Telefax +39 0432 986246

info@fantoni.it

www.fantoni.it



**Fantoni Spa**

*I-33010 Osoppo / Udine  
Telefono +39 0432 9761  
Telefax +39 0432 986246  
info@fantoni.it  
www.fantoni.it*